



# INXPECT SAFETY RADAR EQUIPMENT

Product catalogue



# INXPECT SAFETY PRODUCTS

## Smart Safety

Industrial safety at its best: Inxpect safety radars detect access or presence of operators in dangerous areas, allowing real-time dynamic setting of the detection and warning zones.

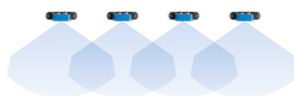
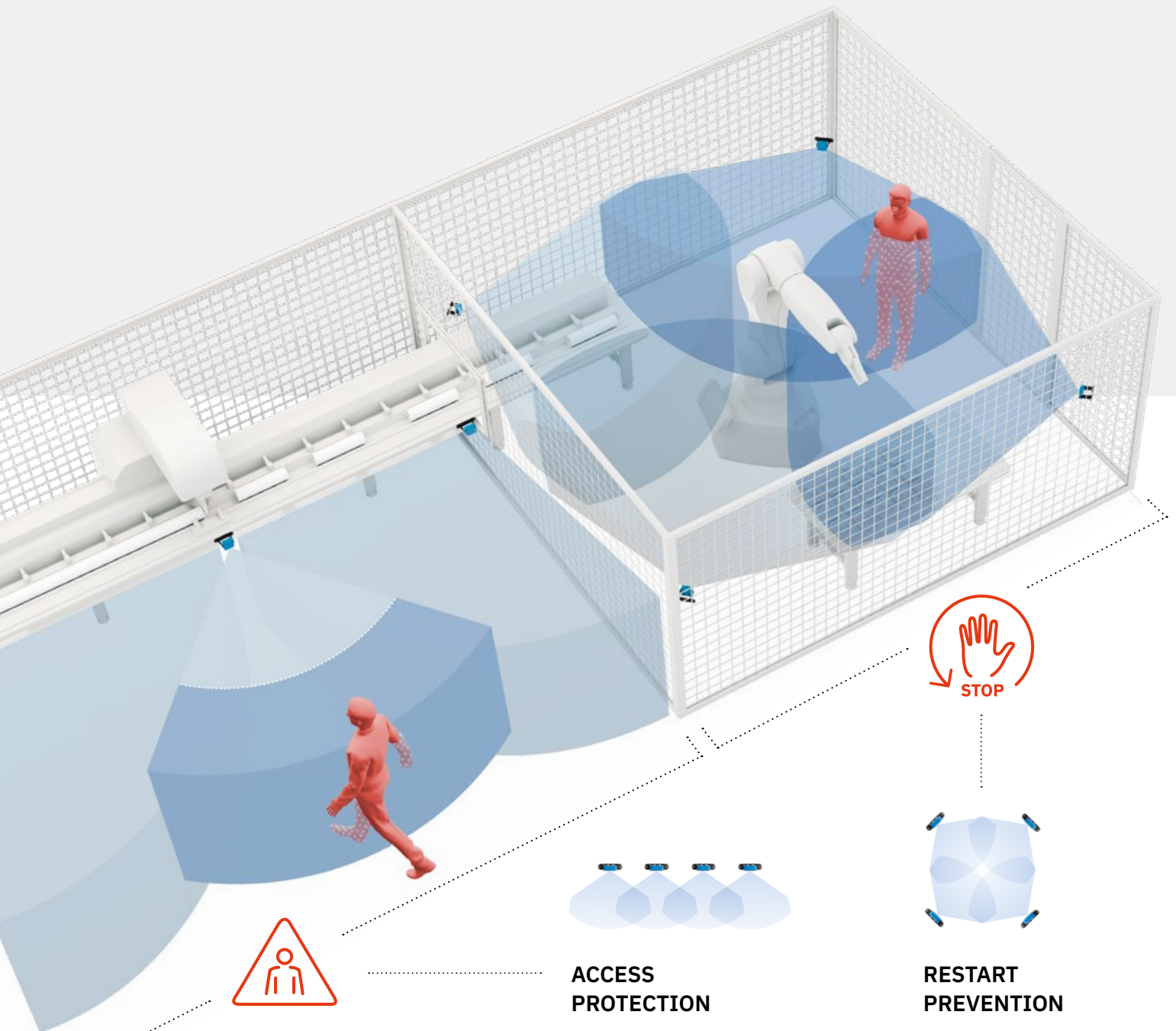

### ACCESS PROTECTION

If the operator moves closer to the dangerous area, it places machinery in a safe state.

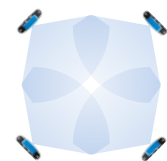

### RESTART PREVENTION

It prevents machinery from restarting while operators are in the dangerous area.

## World's first SIL2/PLd and UL Listed safety radar products



**It works where optical sensors stop.**  
**High safety without compromising productivity**

Optical devices often fail due to dust, smoke, water or waste generated by the production process. The Inxpect team, highly specialized in radar technology, has developed a sophisticated long range radar algorithm that filters out those disturbances, reducing false alarms and increasing productivity.

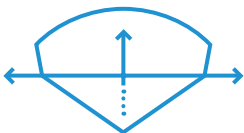

### DYNAMIC MODIFICATION OF THE DETECTION ZONE

The sensor parameters can be configured in real-time, allowing a dynamic modification of the detection zone. This feature makes them perfect solutions for mobile robotic applications.



### IMPROVE THE COMMUNICATION WITH THE MACHINERY

The modular fieldbus allows Inxpect Smart Sensors to exchange safety data, such as the position of the target, in real time with the machinery's PLC. This allows an effective integration with the machinery's control system.



### SECURE CONFIGURATION

Whether you chose USB or Ethernet for configuring Inxpect Safety Radar Products, we got you covered. In all cases, Inxpect control units and the Inxpect Safety Application cooperate in full security.

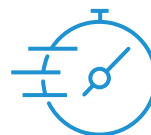

### RESPONSE TIME < 100 ms

With response times lower than 100 ms, you can save space and reduce the area required to stop the machinery.

**INXPECT  
SAFETY APPLICATION**

**INXPECT  
CONTROL UNIT**

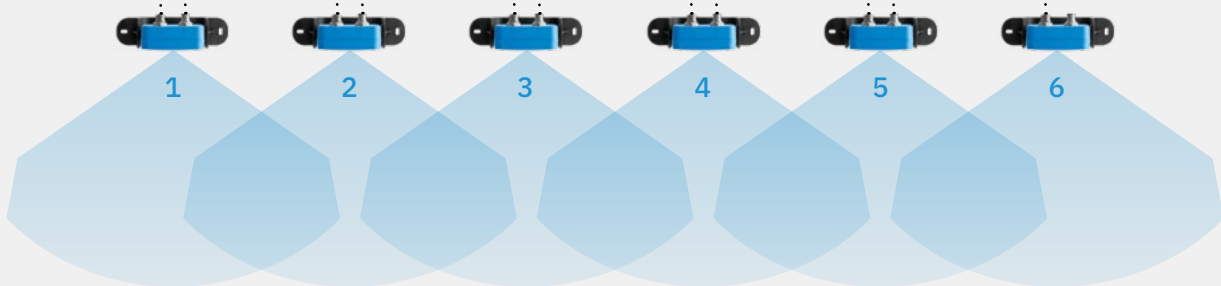
**INXPECT  
SMART RADAR  
SENSORS**

## Flexible, modular, scalable

Inxpect Safety Radar systems are composed of a **control unit** and up to six **smart radar** sensors: high flexibility, from simple to complex scenarios.

Configuring the system is quick and easy, thanks to the user friendly **Inxpect Safety Application**.

Guided validation procedures and the simple generation of the configuration report complete each installation.



A perfect alignment between sensors is not required.



The provided Inxpect Safety Application allows to set up to 32 different configurations to be selected dynamically in real time.



Programmable Muting function: the configuration of sensor groups that can be temporarily muted allows operators to safely access parts of the dangerous area, according to production needs.

# Inxpect Safety Application

The software allows simple and intuitive configuration and subsequent validation of the coverage area. The Inxpect Safety App is a software application that can be installed on any PC or Mac, and that guides the user to the configuration of the volumetric coverage areas of Inxpect safety radar systems, the setting I/O interfaces configuration and system parameters, and the validation process. It is an integral part of all Inxpect safety systems.

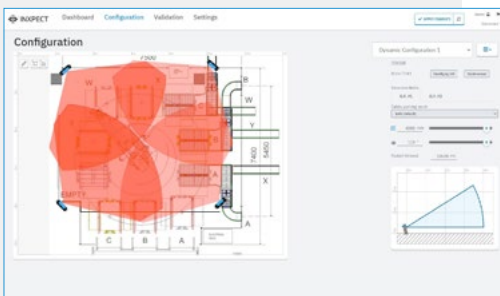
**1**

## SYSTEM CONFIGURATION

Easily set all sensor and control unit parameters, as well as import machinery layouts in different formats.

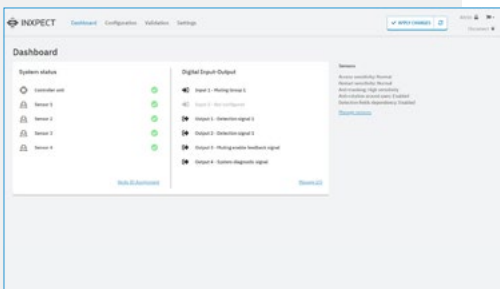
**2**

## SYSTEM STATUS CHECK

Reporting of the status of the control unit and single sensors, outputs and inputs.

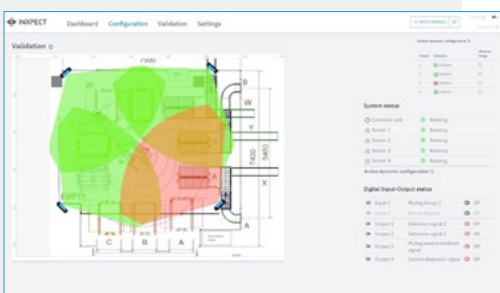
**3**

## SYSTEM VALIDATION

The Inxpect Safety App guides users through the validation of the system and the production of draft validation reports.

# NEW!

**S200 sensors introduce  
Restart Prevention with  
Static Object Detection**

Inxpect radar sensors are designed to monitor the presence of people or moving objects in the area and, at the same time, filter out static objects (these objects do not stop the machine).

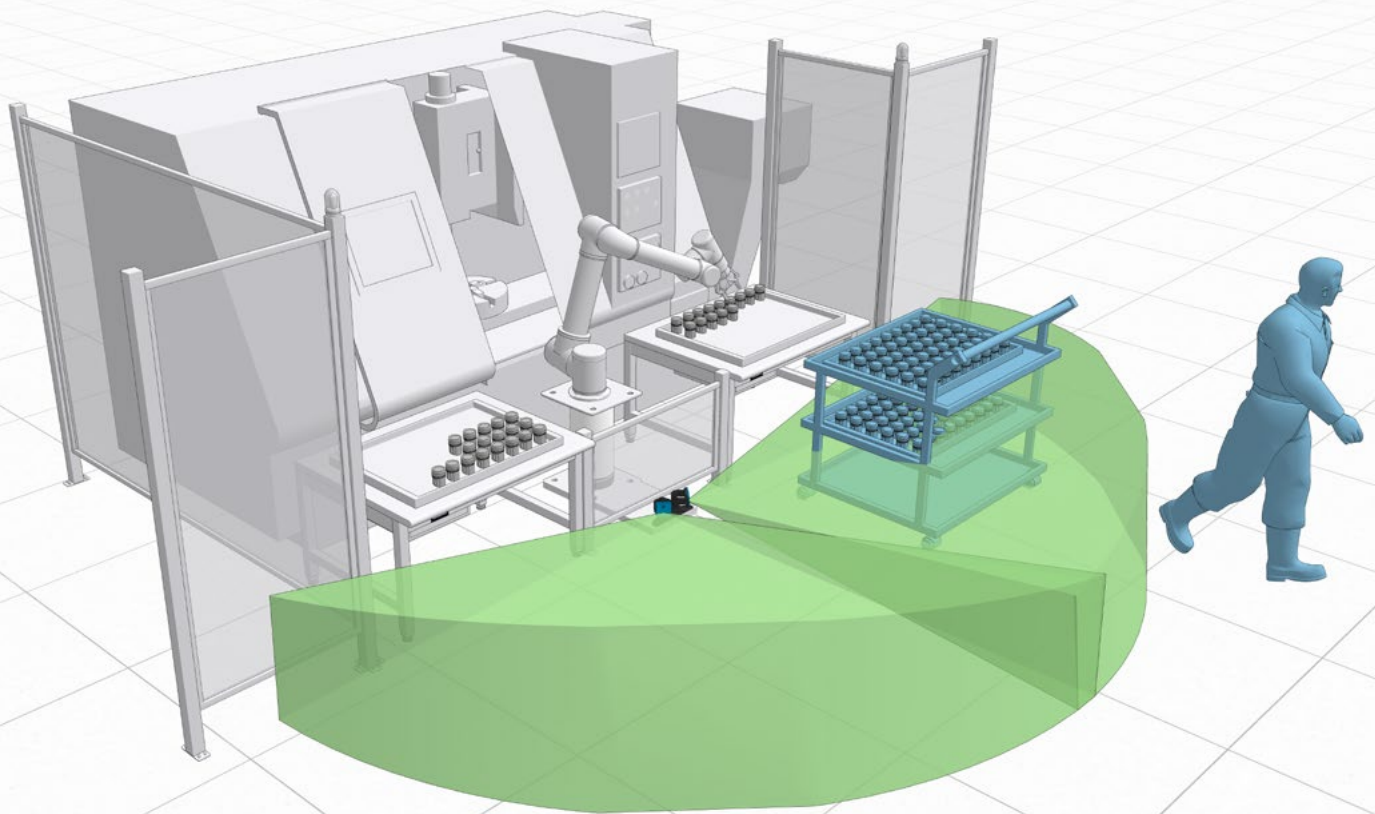

## RESTART PREVENTION

Static objects in the area are filtered out.  
The robot restarts and continues its operating cycle.

Otherwise, if you wish, there is an additional function that you can activate: **Static Object Detection.**

This feature allows you to detect even static objects in the area keeping the machine in stop.

It is particularly important to avoid collision with potential obstacles in mobile applications such as overhead gantries, AGVs, self-driving vehicles, etc.

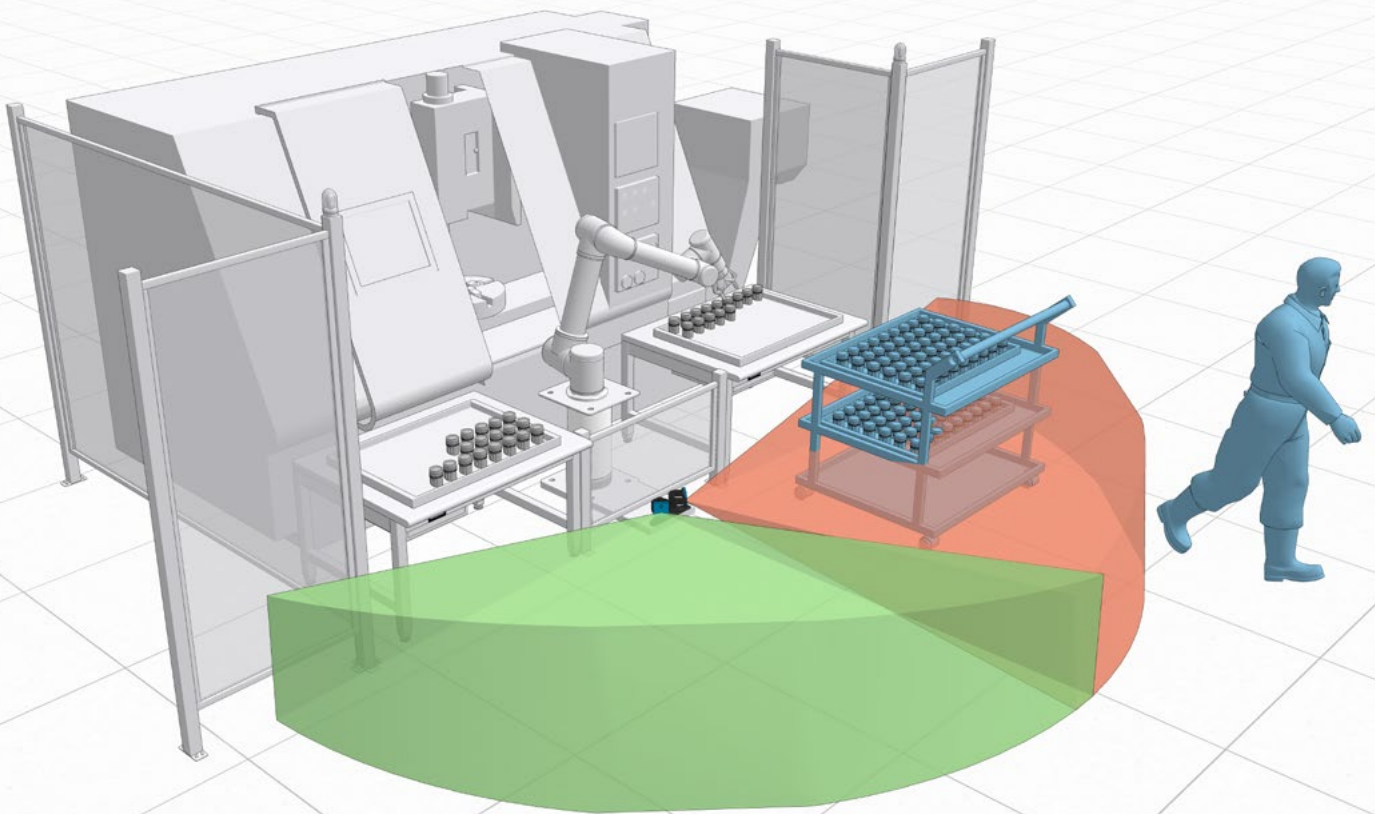

Restart prevention with **STATIC OBJECT DETECTION**

When Static Object Detection is active and there are obstacles in the area the system prevents the restart of the machine.

## Smart Sensors



### 100 SERIES

#### S101A

The world's first SIL-rated and UL listed safety radar sensor



### 200 SERIES

#### S201A

The answer to the demands of complex applications

#### TWO CONFIGURABLE FIELDS OF VIEW (FOV)

##### 1. Wide

Horizontal Plane: 110°  
Vertical Plane: 30°

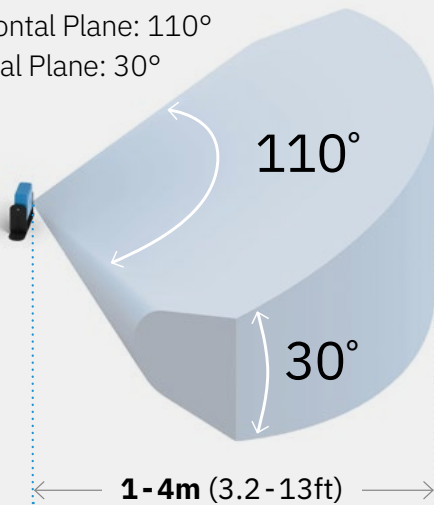

##### 2. Narrow

Horizontal Plane: 50°  
Vertical Plane: 15°

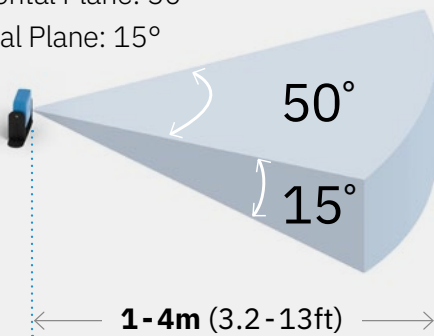

#### Two fixed detection fields

(angles can only be wide or narrow).

Restart time: 10s

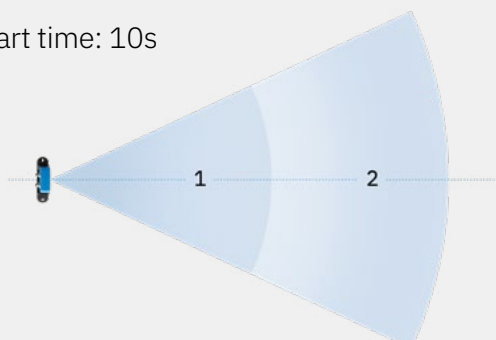

#### THE FIRST MULTI-AREA, DYNAMIC-FIELD 3D SAFETY RADAR

Horizontal Plane: 10-100°  
Vertical Plane: 20°

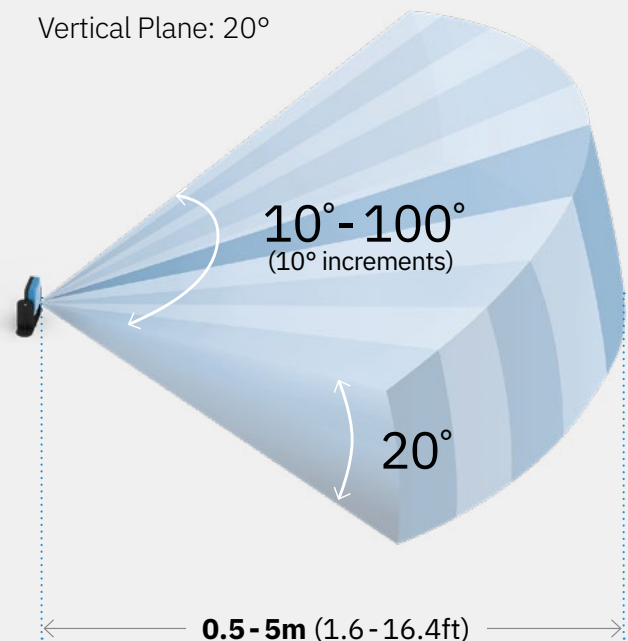

The aperture of each field is dynamically adjustable in 10° increments over a range of 10° to 100°.

Min. configurable distance: 0.5 m.

#### Four independent detection fields

with freely adjustable angles (10°-100°) with a maximum total distance of 5 m.

Restart time: 4s

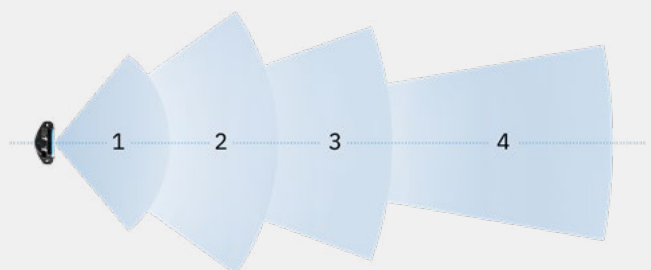





**200 SERIES**

**S201A-MLR**

Ideal for mobile indoor and outdoor applications

**MULTI-AREA, DYNAMIC-FIELD 3D SAFETY RADAR  
EXTENDED RANGE: 9 METERS**

**0.5 - 5m**

Horizontal Plane: 10-100°  
Vertical Plane: 20°

**5 - 9m**

Horizontal Plane: 10-40°  
Vertical Plane: 20°

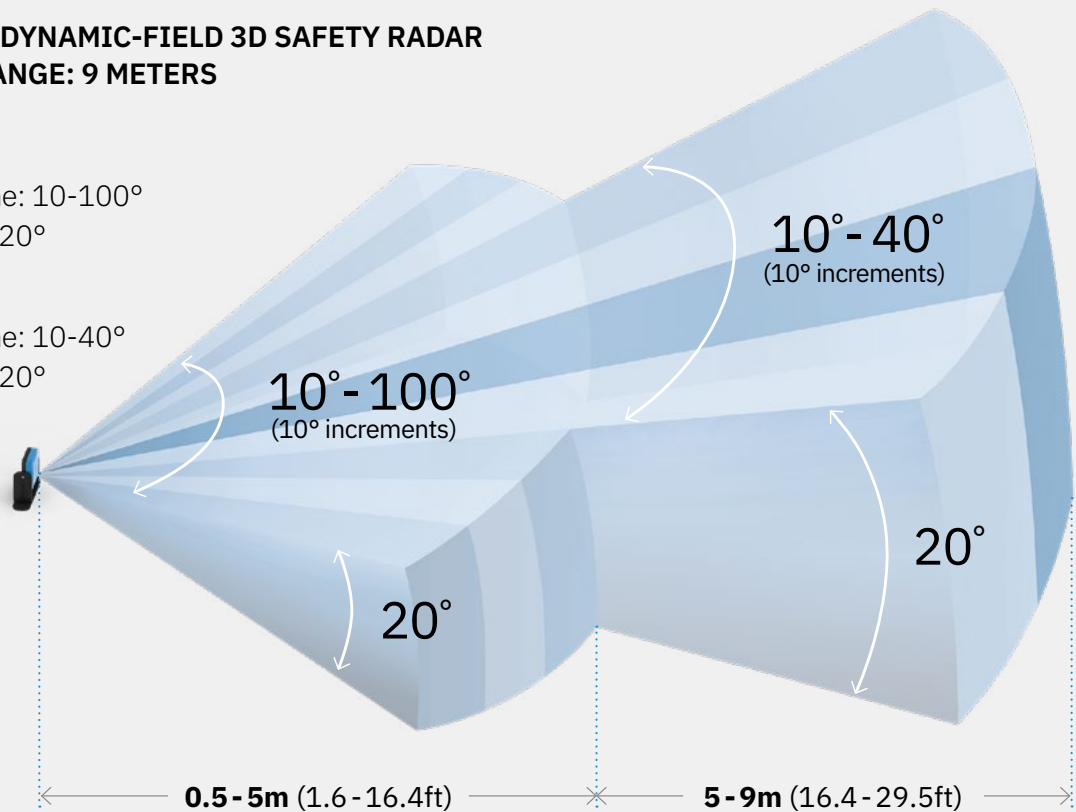

The aperture of each field is dynamically adjustable in 10° increments over a range of 10° to 100° (between 0.5 and 5 m) and over a range of 10° to 40° (between 5 and 9 m).

Min. configurable distance: 0.5 m.

**Four independent detection fields** with freely adjustable angles (10°-100° between 0.5 and 5 m, 10°-40° between 5 and 9 m) with a maximum total distance of 9 m.

Restart time: 4s

Target speed: 4 m/s

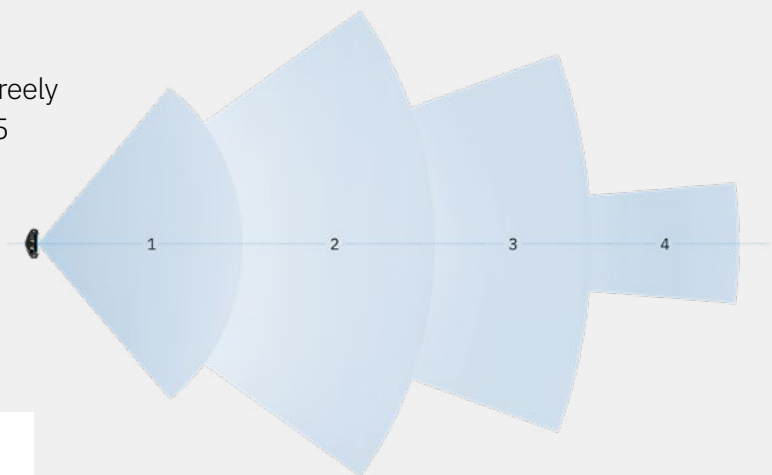

The RCS of the target can be selected for human safety or for collision with other object.



# S101A

Part No. **90202011**



### Safety Parameters:

- SIL2 (IEC 61508)
- PLd, Cat. 2 (ISO 13849)

## Smart Sensor 100 SERIES 24 GHz Radar

The **S101A** sensor is a smart FMCW (Frequency Modulated Continuous Wave) radar device based on proprietary Inxpect detection algorithms. The sensor sends 24 GHz radio waves and recovers motion information, analyzing the returned signals reflected by both static and moving objects in the operative range.

The sensors perform the following primary functions:

- **Motion and scenario analysis.**
- **Communication to the control unit of processed motion data and diagnostic information.**



### Certification

Scan the QR Code to open the Regulatory Notice Page



### Technical details

<i>Frequency</i>	24 GHz ISM license-free
<i>Connectors</i>	Two 5-pin M12 connectors (1 male and 1 female)
<i>CAN bus termination resistance</i>	120 Ω (not supplied, to be installed with termination connector)
<i>Power supply</i>	12 V dc ± 20%, through control unit
<i>Power consumption</i>	1.2 W
<i>Degree of protection</i>	IP67
<i>Operating temperature</i>	From -30 to +60 °C (-22 to +140 °F)
<i>Case material</i>	Sensor: PA66   Bracket: PA66 and glass fiber (GF)

# S201A

Part No. **90302011**



### Safety Parameters:

- SIL2 (IEC 61508)
- PLd, Cat. 3 (ISO 13849)
- Performance Class D (IEC/TS 62998-1)

## Smart Sensor 200 SERIES 60GHz Radar

The **S201A** sensor is a smart FMCW (Frequency Modulated Continuous Wave) radar device based on proprietary Inxpect detection algorithms. Operating in the millimeter wave V band (60 GHz), it can detect complex scenes by analyzing the returned signals reflected by both static and moving objects in the operative range. With dynamically selectable horizontal field of view and up to four alarm areas, it is ideal for complex application scenarios, including mobile use cases.

The sensors perform the following primary functions:

- **Motion and scenario analysis.**
- **Communication to the control unit of processed motion data and diagnostic information.**
- **Static Object Detection: this new option allows to detect static objects in the area where the restart prevention safety function is activated.**



2 axes bracket

### Certification

Scan the QR Code to open the Regulatory Notice Page



### Technical details

Frequency	Millimeter waves V-band: 60 GHz
Connectors	Two 5-pin M12 connectors (1 male and 1 female)
CAN bus termination resistance	120 Ω (not supplied, to be installed with termination connector)
Power supply	12 V dc ± 20%, through control unit
Power consumption	2.8 W
Degree of protection	IP67
Operating temperature	From -30 to +60 °C (-22 to +140 °F)
Case material	Sensor: PA66 (front) + Aluminum (back)   Bracket: PA66 and glass fiber (GF)

# S201A-MLR

Part No. **90305010**



### Safety Parameters:

- SIL2 (IEC 61508)
- PLd, Cat. 3 (ISO 13849)
- Performance Class D (IEC/TS 62998-1)

## Smart Sensor 200 SERIES

### 60 GHz Radar Long Range

The **S201A-MLR** sensor operates in the millimeter wave V band (60 GHz) and it can detect complex scenes by analyzing the returned signals reflected by both static and moving objects in the operative range.

In addition to the dynamically selectable horizontal field of view and up to four alarm areas, S201A-MLR also supports higher speeds (4 m/s) and longer ranges (9 meters) than the base S201A model. The **S201A-MLR** is therefore ideal in sectors like earth moving, railway, mining and agriculture.

As an additional function, the target RCS can be chosen among different values:

- Human RCS (for the “standard” safety function)
- Selectable RCS (for preventing collision with other objects)

The sensors perform the following primary functions:

- **Motion and scenario analysis.**
- **Communication to the control unit of processed motion data and diagnostic information.**
- **Static Object Detection: this new option allows to detect static objects in the area where the restart prevention safety function is activated. By doing so it prevents the mobile device from restarting when there are obstacles in the area.**

#### Certification

Scan the QR Code to open the Regulatory Notice Page



#### Technical details

Frequency	Millimeter waves V-band: 60 GHz
Connectors	Two 5-pin M12 connectors (1 male and 1 female)
CAN bus termination resistance	120 Ω (not supplied, to be installed with termination connector)
Power supply	12 V dc ± 20%, through control unit
Power consumption	2.8 W
Degree of protection	IP67
Operating temperature	From -30 to +60 °C (-22 to +140 °F)
Case material	Sensor: PA66 (front) + Aluminum (back)   Bracket: PA66 and glass fiber (GF)

### 3 Axes bracket



### 3 Axes Configuration for S201A and S201A-MLR sensors

The advanced bracket system makes the installation and positioning of Inxpect's sensors easy and quick. The rotation around X and Z axes allows to optimise the coverage of the dangerous area by the FOV of the sensor, while the rotation around Y axis allows to take advantage of both horizontal and vertical angular coverage. The bracket system is perfect for the installation of the sensor on both horizontal and vertical surfaces.

Thanks to this bracket solution the S201A and S201A-MLR sensors can rotate on three axes (x, y, z).



## Control Units



**200 SERIES**  
**C201A**  
PROFIsafe,  
Ethernet and  
digital I/O



**200 SERIES**  
**C202A**  
Ethernet and  
digital I/O



**200 SERIES**  
**C203A**  
Digital I/O

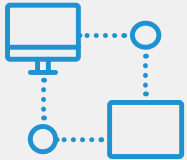

### ADVANCED CONNECTIVITY

- Safety Fieldbus
- Secure Ethernet
- MODBUS communication
- USB
- Digital I/O, including two dual-channel Safety Outputs



### DYNAMIC SETTING OF DETECTION FIELDS

Up to 32 configurations switchable in real time



### SECURE ETHERNET CONFIGURATION

#### Safety Parameters:

- SIL2 (IEC 61508)
- PLd, Cat. 3 (ISO 13849)
- Performance Class D (IEC/TS 62998-1)

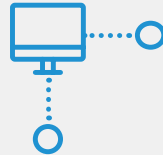

### SIMPLE CONNECTIVITY

- Secure Ethernet
- MODBUS communication
- USB
- Digital I/O, including two dual-channel Safety Outputs



### DYNAMIC SETTING OF DETECTION FIELDS

Up to 4 configurations switchable in real time



### SECURE ETHERNET CONFIGURATION

#### Safety Parameters:

- SIL2 (IEC 61508)
- PLd, Cat. 3 (ISO 13849)
- Performance Class D (IEC/TS 62998-1)

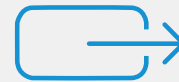

### BASIC CONNECTIVITY

- USB
- Digital I/O, including two dual-channel Safety Outputs



### DYNAMIC SETTING OF DETECTION FIELDS

Up to 4 configurations switchable in real time



### SECURE USB CONFIGURATION

#### Safety Parameters:

- SIL2 (IEC 61508)
- PLd, Cat. 3 (ISO 13849)
- Performance Class D (IEC/TS 62998-1)

# C201A

Part No. **90301011**

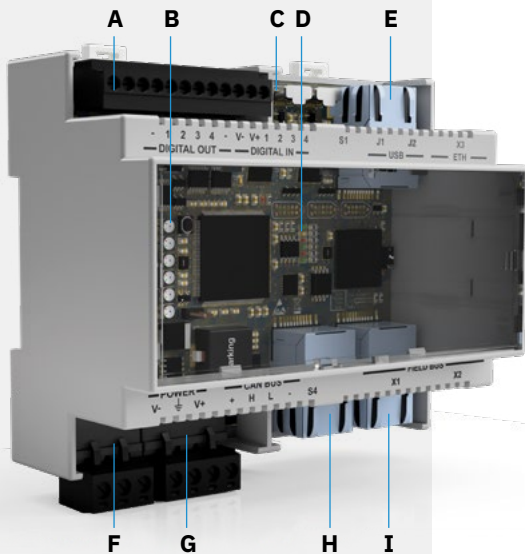

- A** - I/O terminal block
- B** - System status LED
- C** - Micro USB port
- D** - Fieldbus status LED
- E** - Ethernet port
- F** - Power supply terminal block
- G** - CAN bus terminal block for connecting the first sensor
- H** - Ethernet Fieldbus port n. 1
- I** - Ethernet Fieldbus port n. 2



## Control Unit 200 SERIES PROFIsafe, Ethernet and digital I/O

**C201A** is the most advanced control unit for Inxpect safety radars, with the widest range of communication options. The Inxpect Safety Application allows the configuration of sensitivity levels, safety functions, size of detection fields, and the functionality of the I/O ports of the control unit.

### Safety fieldbus

Currently supporting PROFIsafe fieldbus protocol.

### Secure Ethernet

Remote configuration and management protected by industry standard cyber-security protocols.

### USB

Local configuration option.

### Digital inputs

Two dual-channel inputs supporting the following functions:

- muting signal
- emergency stop signal
- restart signal

### Four Output Signal Switching Devices

*As safety outputs:* two dual-channel safety OSSDs.

*As auxiliary outputs:* four auxiliary outputs, which can be configured to signal restart feedback, fault, muting status.

### Dynamic detection fields

All detection fields can be dynamically modified in real-time: up to two detection fields for Inxpect SRE 100 Series and up to four detection fields for Inxpect SRE 200 Series.

#### Certification

Scan the QR Code to open the Regulatory Notice Page



#### Technical details

<b>Outputs</b>	4 Outputs Signal Switching Devices (OSSDs) or 2 dual channel safety outputs
<b>Safety outputs</b>	High-side outputs (with extended protection function) Max voltage: 30 V dc   Max current: 0.4 A   Max power: 12 W
<b>Inputs</b>	2 dual channel TYPE3 digital inputs with common GND
<b>Fieldbus interface</b>	Ethernet based safety fieldbus (e.g. PROFIsafe)
<b>MODBUS interface</b>	Ethernet interface for real time data monitoring
<b>Power supply</b>	24 V dc (20–28 V dc) Max current: 1 A (no OSSD)
<b>Max power consumption</b>	5 W (no OSSD)
<b>Assembly</b>	DIN guide
<b>Degree of protection</b>	IP20
<b>Terminals</b>	Section: 1 mm <sup>2</sup>   Max Current: 4 A with 1 mm <sup>2</sup> cables
<b>System configuration</b>	Ethernet, USB

# C202A

Part No. 90303011

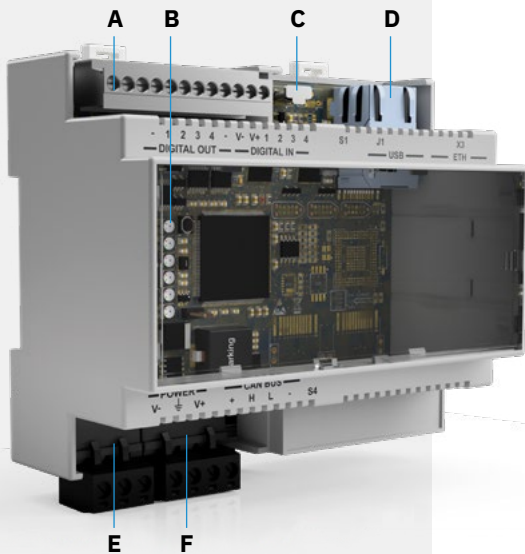

- A** - I/O terminal block
- B** - System status LED
- C** - Micro USB port
- D** - Ethernet port
- E** - Power supply terminal block
- F** - CAN bus terminal block for connecting the first sensor

106 mm (4.17 in)



58 mm (2.28 in)

90 mm (3.54 in)

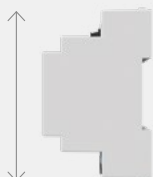

## Control Unit 200 SERIES

### Ethernet and digital I/O

**C202A** offers both USB and Ethernet communication interfaces, providing local and remote configuration options. In both cases, the Inxpect Safety Application allows the configuration of sensitivity levels, safety functions, size of detection fields, and the functionality of the I/O ports of the control unit.

#### Secure Ethernet

Remote configuration and management protected by industry standard cyber-security protocols.

#### USB

Local configuration option.

#### Digital inputs

Two dual-channel inputs supporting the following functions:

- muting signal
- emergency stop signal
- restart signal

#### Four Output Signal Switching Devices

*As safety outputs:* two dual-channel safety OSSDs.

*As auxiliary outputs:* four auxiliary outputs, which can be configured to signal restart feedback, fault, muting status.

#### Dynamic detection fields

All detection fields can be dynamically modified in real-time: up to two detection fields for Inxpect SRE 100 Series and up to four detection fields for Inxpect SRE 200 Series.

#### Certification

Scan the QR Code to open the Regulatory Notice Page



#### Technical details

<b>Outputs</b>	4 Outputs Signal Switching Devices (OSSDs) or 2 dual channel safety outputs
<b>Safety outputs</b>	High-side outputs (with extended protection function) Max voltage: 30 V dc   Max current: 0,4 A   Max power: 12 W
<b>Inputs</b>	2 dual channel TYPE3 digital inputs with common GND
<b>MODBUS interface</b>	Ethernet interface for real time data monitoring
<b>Power supply</b>	24 V dc (20–28 V dc) Max current: 1A (no OSSD)
<b>Max power consumption</b>	5 W (no OSSD)
<b>Assembly</b>	DIN guide
<b>Degree of protection</b>	IP20
<b>Terminals</b>	Section: 1 mm <sup>2</sup>   Max Current: 4A with 1 mm <sup>2</sup> cables
<b>System configuration</b>	Ethernet, USB



# C203A

Part No. **90304011**

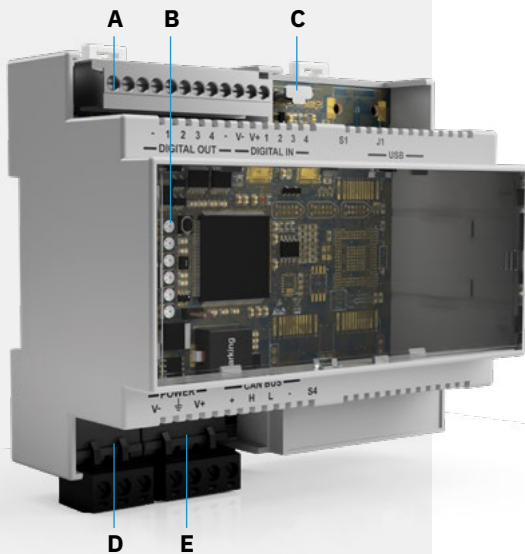

- A** - I/O terminal block
- B** - System status LED
- C** - Micro USB port
- D** - Power supply terminal block
- E** - CAN bus terminal block for connecting the first sensor



## Control Unit 200 SERIES Digital I/O

**C203A** provides basic but robust control functionality for any Inxpect safety radar sensor. The Inxpect Safety Application works via USB to configure the sensitivity levels, safety functions, size of detection fields, and the functionality of the I/O ports of the control unit.

### USB

Local configuration option.

### Digital inputs

Two dual-channel inputs supporting the following functions:

- muting signal
- emergency stop signal
- restart signal

### Four Output Signal Switching Devices

*As safety outputs:* two dual-channel safety OSSDs.

*As auxiliary outputs:* four auxiliary outputs, which can be configured to signal restart feedback, fault, muting status.

### Dynamic detection fields

All detection fields can be dynamically modified in real-time: up to two detection fields for Inxpect SRE 100 Series and up to four detection fields for Inxpect SRE 200 Series.

#### Certification

Scan the QR Code to open the Regulatory Notice Page



#### Technical details

<b>Outputs</b>	4 Outputs Signal Switching Devices (OSSDs) or 2 dual channel safety outputs
<b>Safety outputs</b>	High-side outputs (with extended protection function) Max voltage: 30 V dc   Max current: 0,4 A   Max power: 12 W
<b>Inputs</b>	2 dual channel TYPE3 digital inputs with common GND
<b>Power supply</b>	24 V dc (20–28 V dc) Max current: 1A (no OSSD)
<b>Max power consumption</b>	5 W (no OSSD)
<b>Assembly</b>	DIN guide
<b>Degree of protection</b>	IP20
<b>Terminals</b>	Section: 1 mm <sup>2</sup>   Max Current: 4A with 1 mm <sup>2</sup> cables
<b>System configuration</b>	USB

# Accessories

Part No. 90202ZAA

## Metal protector For Smart Sensor 100 SERIES

The metal protector ensures that Inxpect S101A sensors perform at their best even in the most challenging environmental conditions, increasing their immunity to spurious detections while reducing the possibility of damage caused by accidental impact.

AISI 304 Stainless steel

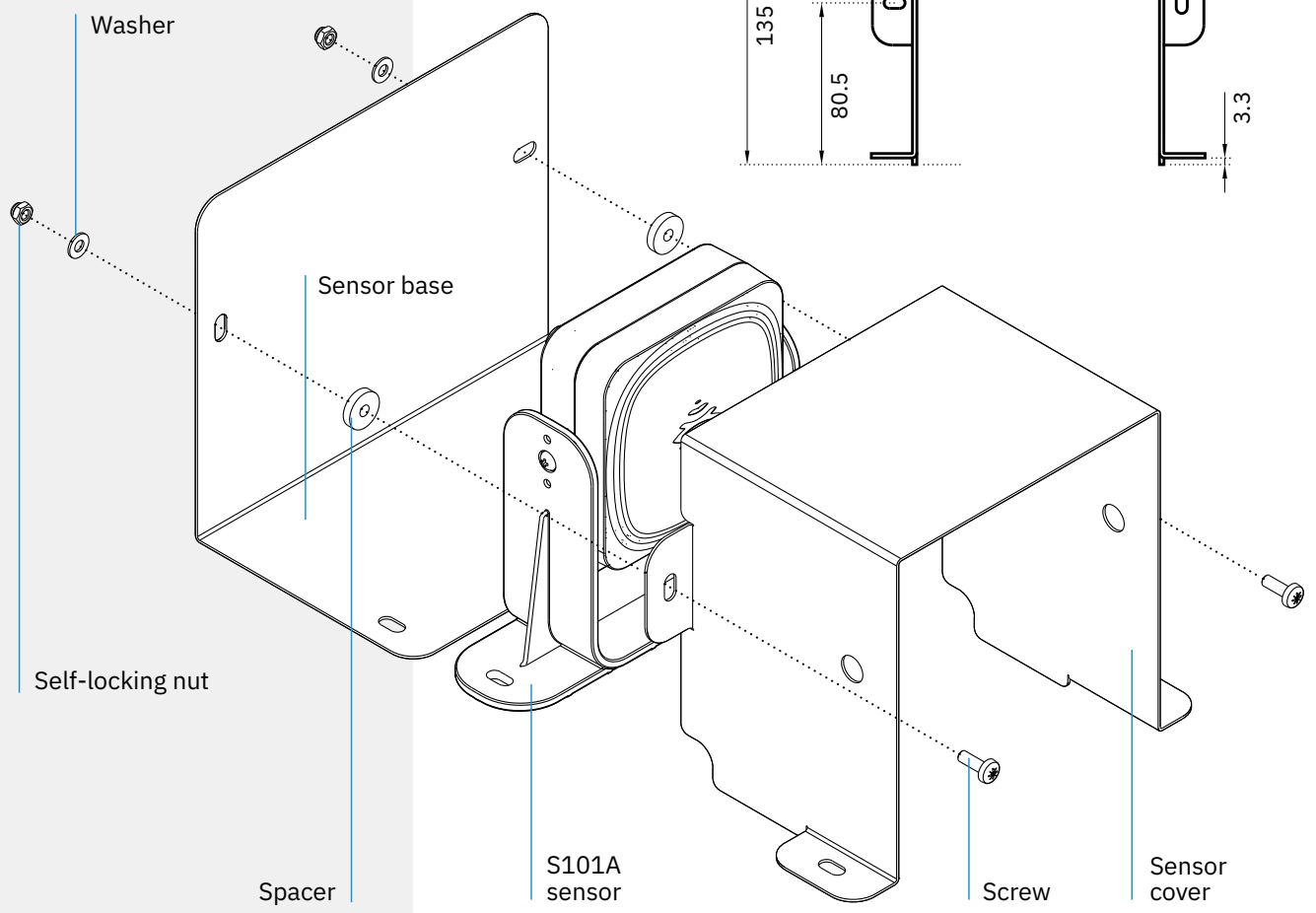
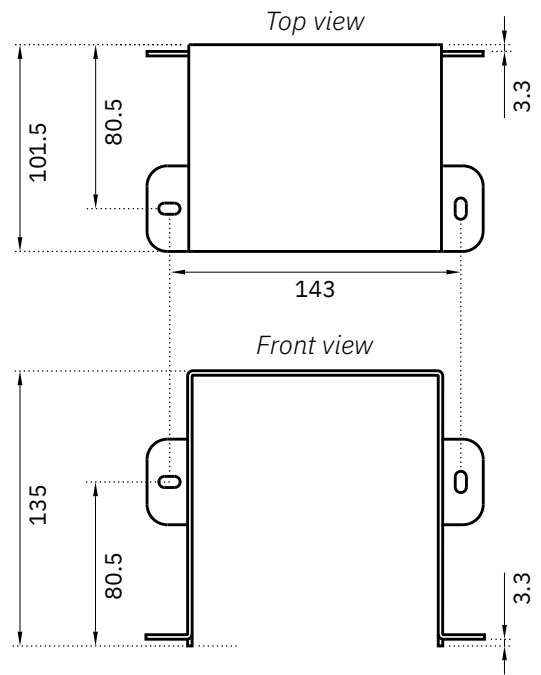

# Accessories



## Cables

### Control unit to sensor cable:

CAN bus, totally shielded.

**Control unit side:** free wires

**Sensor side:** connector M12, female, 5 poles, A-coded, angled 90°

	Smart Sensor 100 SERIES	Smart Sensor 200 SERIES
5 m	Part No. <b>08000003</b>	Part No. <b>08000110</b>
10 m	Part No. <b>08000004</b>	Part No. <b>08000111</b>
15 m	Part No. <b>08000006</b>	Part No. <b>08000112</b>
20 m	-	Part No. <b>08000113</b>
30 m	-	Part No. <b>08000114</b>

Which cables and lengths do you need for your system?  
Find out with our utility: [Cable Validator](#) (Sign in to Inxpect Tools).



### Sensor to sensor cable:

CAN bus, totally shielded.

**IN side:** connector M12, female, 5 poles, A-coded, angled 90°

**OUT side:** connector M12, male, 5 poles, A-coded, angled 90°

	Smart Sensor 100 SERIES	Smart Sensor 200 SERIES
3 m	Part No. <b>08000007</b>	Part No. <b>08000120</b>
5 m	Part No. <b>08000013</b>	Part No. <b>08000121</b>
10 m	-	Part No. <b>08000122</b>
15 m	Part No. <b>08000016</b>	Part No. <b>08000123</b>

Which cables and lengths do you need for your system?  
Find out with our utility: [Cable Validator](#) (Sign in to Inxpect Tools).



### Bus terminator:

M12, male, 5 poles, A-coded, straight 180°, resistance 120 Ω

Part No. **07000003**



## Inxpect Safety Radar Equipment

# USE CASES

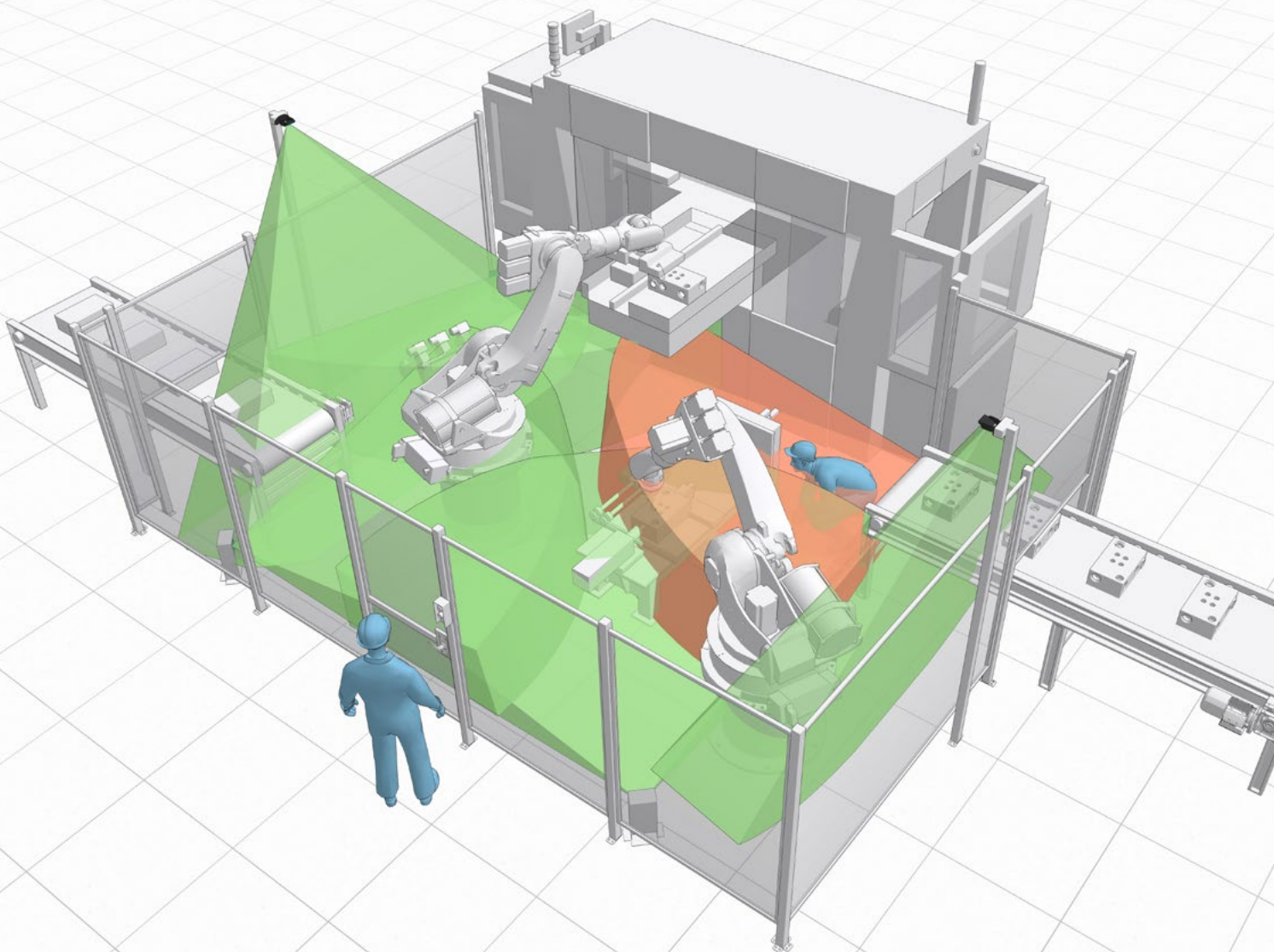

# Restart prevention

## Higher safety in robotic cells

Inxpect refines the state of art of robotics cell and the world of industrial safety in general. Inxpect 3D radars ensure maximum safety within dangerous areas by preventing unintentional restart while operator is in the dangerous area.

Main features:

- Natively 3D: volumetric coverage
- Adaptive to changing scenarios
- Prevent unintentional restarts
- Simplify access procedures
- Remove human error
- Improve productivity

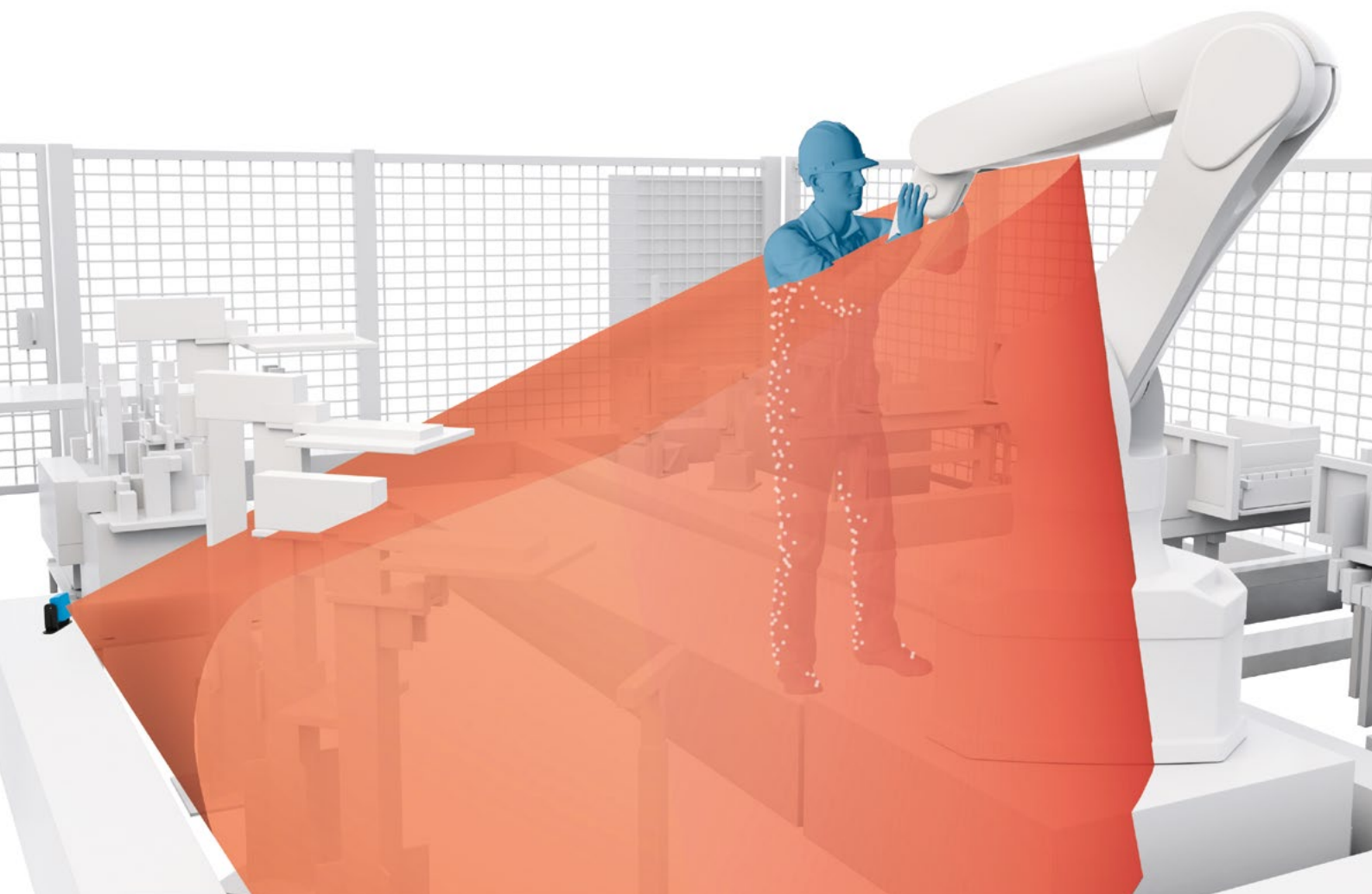

# Restart prevention

## Higher safety in wrapping stations

Inxpect redefines the state of the art of automatic wrapping and strapping stations. Inxpect 3D radars simplify human/machine interaction, prevent unintentional restarts and reduce residual risks, increasing efficiency and productivity.

Main features:

- Natively 3D: volumetric coverage
- Adaptive to changing scenarios
- Prevent accidental restart
- Simplify access procedures
- Improve human/machine interaction
- Remove human error
- Improve productivity

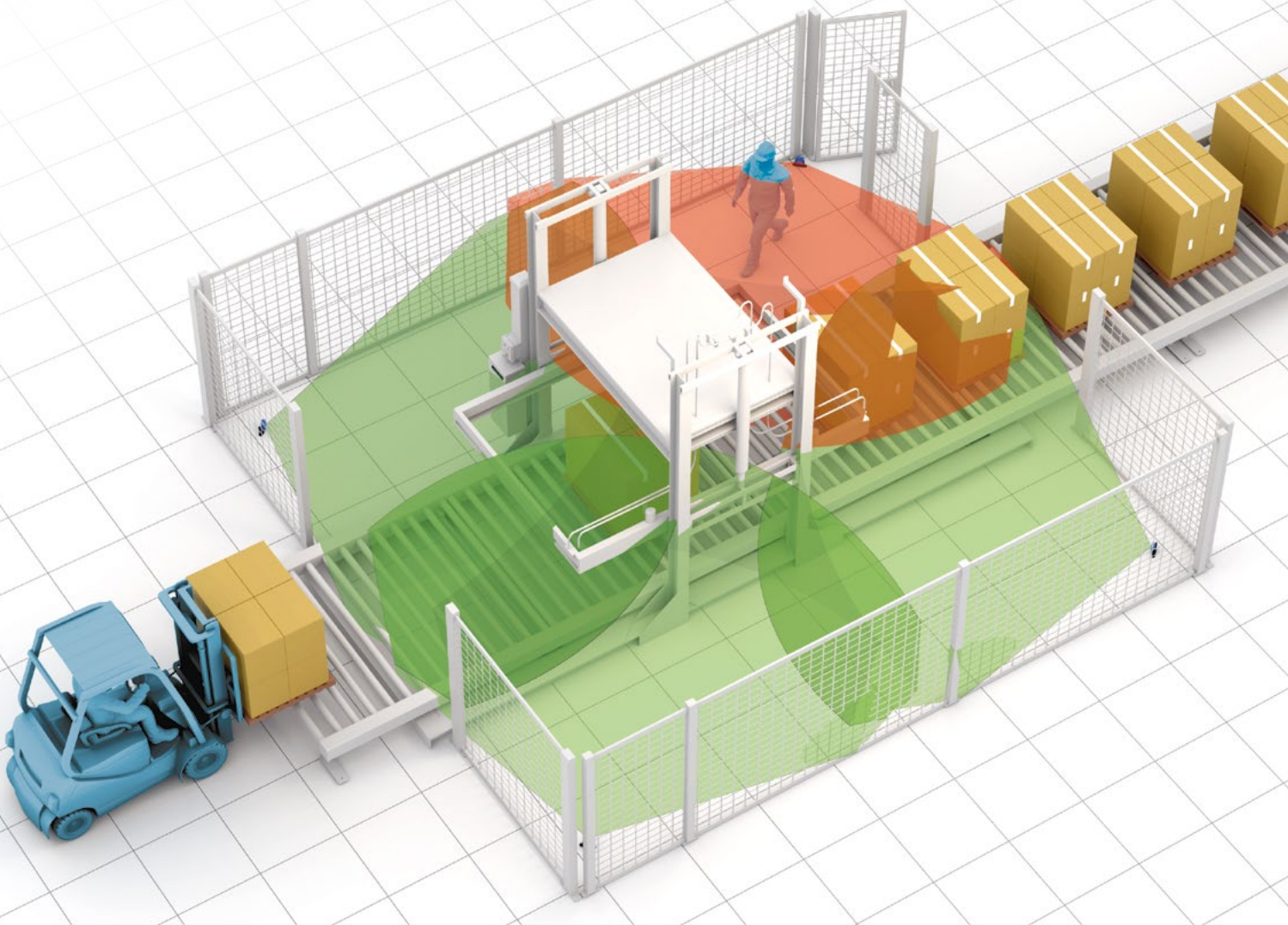

# Smart collision avoidance

## Indoor application: Pick and Place

Inxpect brings dynamic safety to pick and place applications. Inxpect 3D radar simplifies human/machine interaction, provides highly dynamic protection and allows for simple programming. Being adaptive to changing scenarios, Inxpect 3D radar increases efficiency and productivity.

Main features:

- Natively 3D: volumetric coverage
- Adaptive to changing scenarios
- Highly dynamic protection
- Simple programming

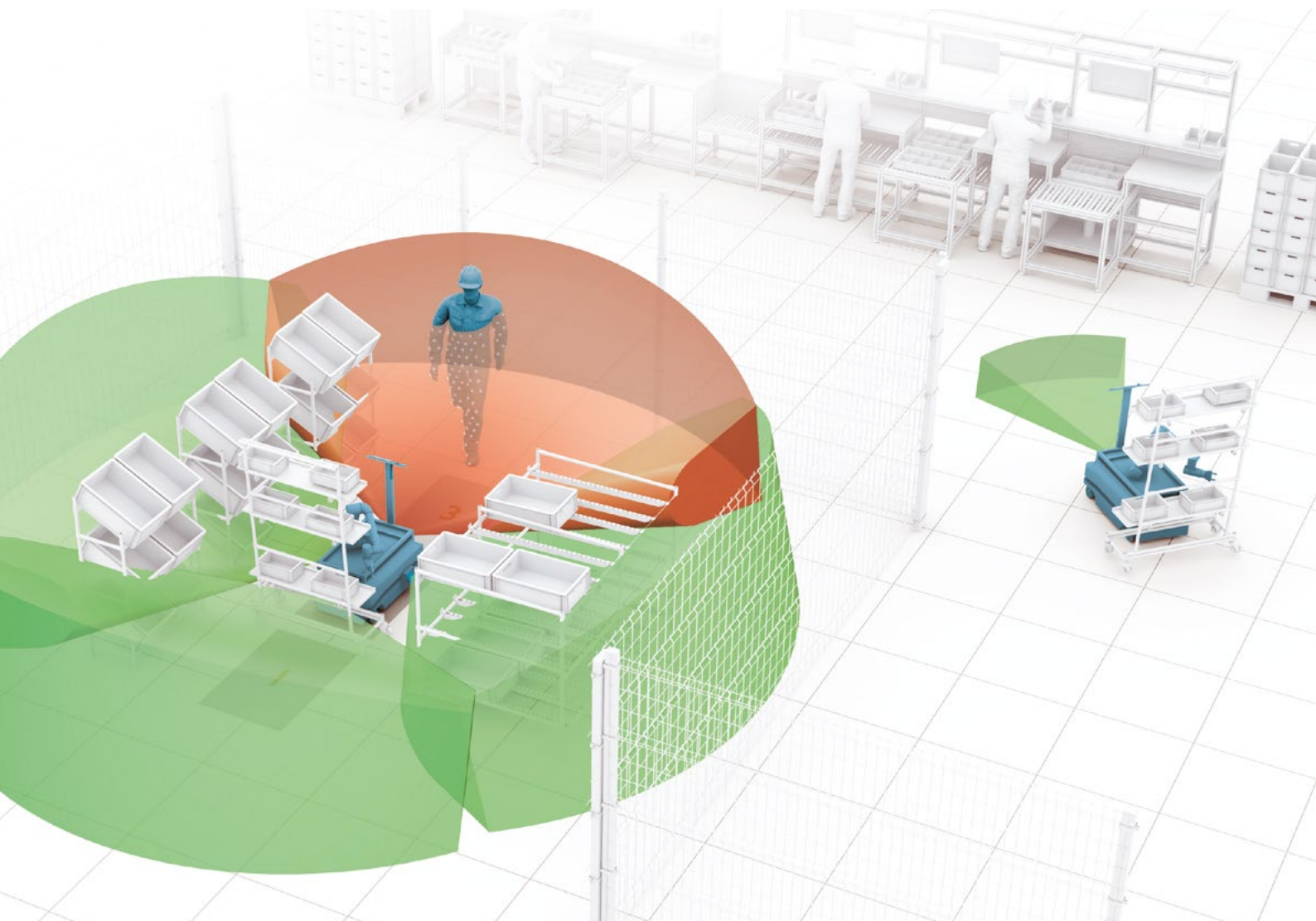



# Smart collision avoidance

## Indoor application: Automated Guided Vehicle

Inxpect brings dynamic safety to AGV. Inxpect 3D radars are ideal anti-collision sensor: they're robust to dust, debris, smoke, rain and light reflections. They are effective at detecting suspending loads, provide volumetric coverage and fit perfectly for indoor and outdoor applications.

Main features:

- Natively 3D: volumetric coverage
- Effective at detecting suspended loads
- Robust to smoke, dust, debris, rain, fog, snow and light reflections
- Indoor and outdoor applications

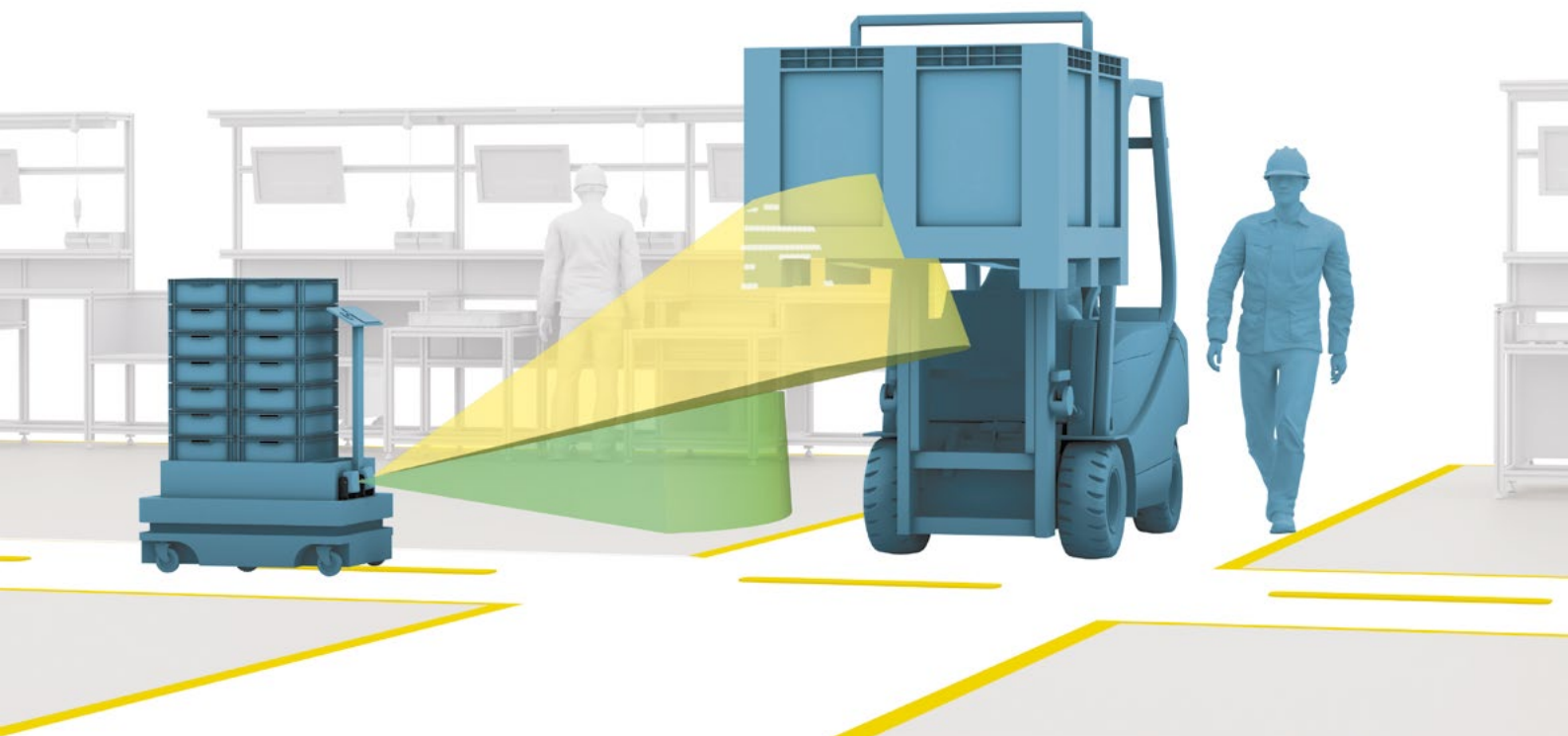

# Smart collision avoidance

## Outdoor application: Construction Site

Inxpect ensures maximum safety even in harsh environmental conditions. Inxpect 3D radars are an excellent aid to monitoring of the movement areas of operating machines because they allow to have a complete analysis of the area, even on multiple levels.

Main features:

- Robust to smoke, dust, debris, rain, fog, snow and light reflections
- Reduce false alarms
- Indoor and outdoor applications
- 3D radar: volumetric protection
- Operating temperature  $-30^{\circ}$   $+60^{\circ}$

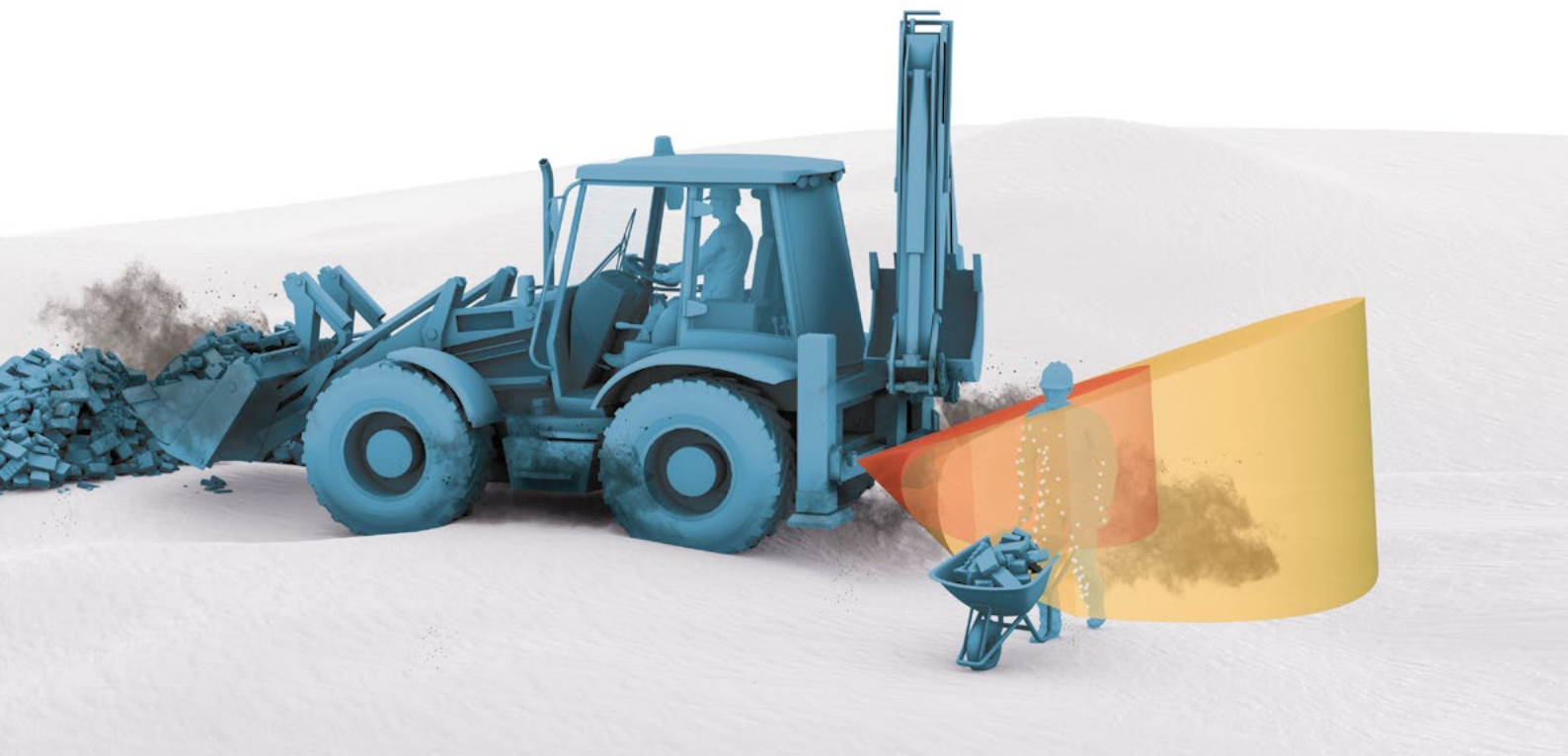

# Smart collision avoidance

## Outdoor application: Construction Site

Inxpect ensures maximum safety even in harsh environmental conditions. Dust, fog, rain and swarf generated by production processes do not cause false alarms. The volumetric coverage of Inxpect 3D radars prevents collision with suspended loads or airborne elements.

Main features:

- Robust to smoke, dust, debris, rain, fog, snow and light reflections
- Reduce false alarms
- 3D radar: volumetric protection
- Operating temperature  $-30^{\circ}$   $+60^{\circ}$

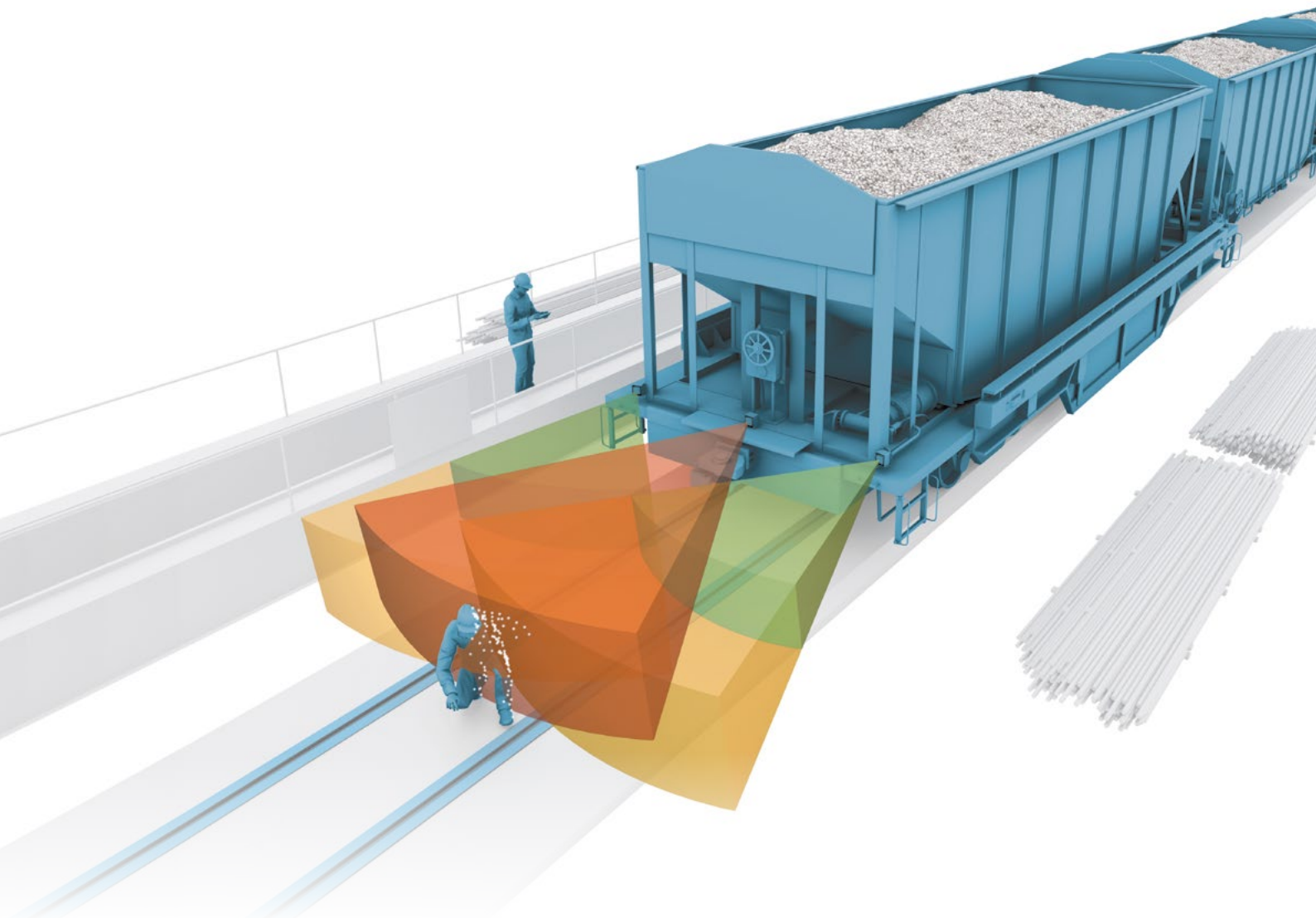

# Access protection

## Dynamic safety for mobile gantry machining

Inxpect redefines safety for mobile gantry machining. Thanks to the volumetric coverage, Inxpect 3D radars secure both the floor and the work surface, always ensuring maximum safety for operators.

Main features:

- Robust to debris: no more false alarms
- Natively 3D: volumetric coverage (for both floor and work surface areas)
- Prevent unintentional restarts while operator is in the dangerous area
- Remove human error

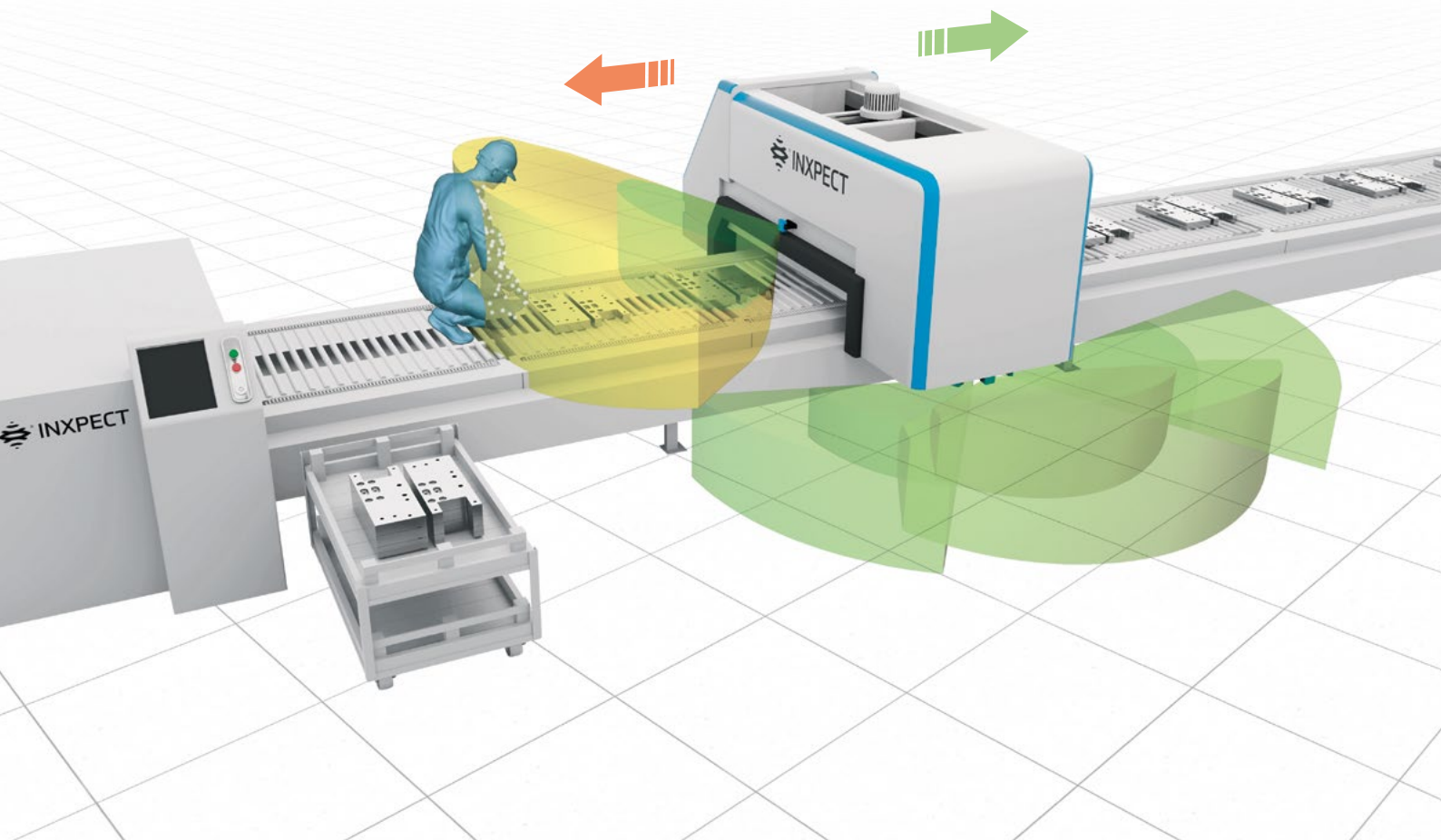

# Access protection

## Higher safety in robotic welding systems

Inxpect redefines safety for robotic welding systems with double electric rotary tables. Inxpect 3D radars can be positioned to create a volumetric barrier for access protection, increasing the safety of the setup while dramatically improving productivity.

Main features:

- Natively 3D: volumetric coverage
- Robust to debris: no more false alarms
- Virtually remove the need for protection barriers
- Simplify human/machine interaction
- Speed up the working process
- Improve productivity

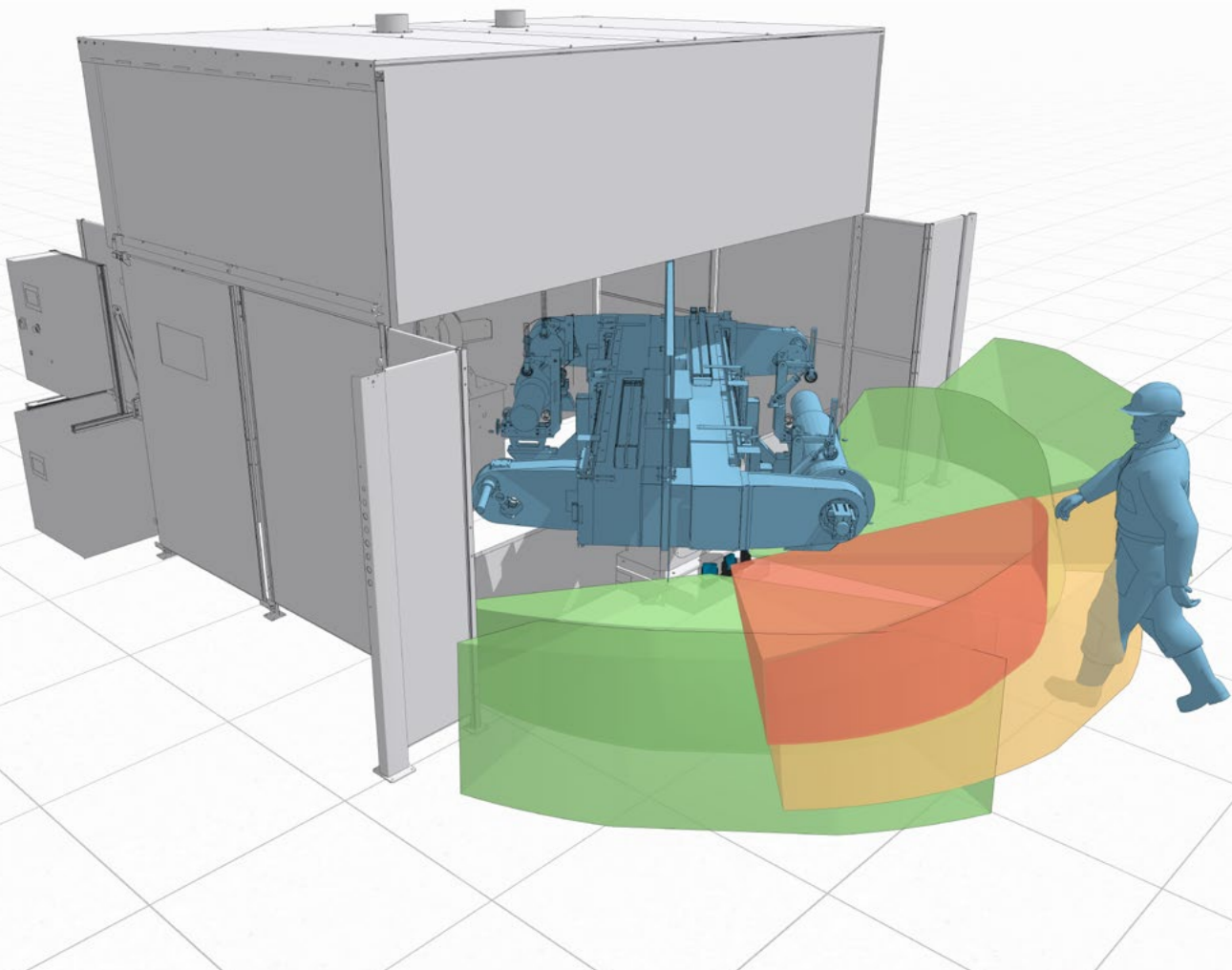

# Access protection

## Dynamic safety for robotic cells

Inxpect redefines safety for robotic cells. Thanks to the dynamic configurations, Inxpect's 3D radar sensors monitor the entrance to the dangerous area, always guaranteeing maximum safety for operators and at the same time without ever stopping the operating cycle of the machinery.

Main features:

- Dynamic configurations
- 3D radar: volumetric protection
- Simplify human/machine interaction
- Improve productivity

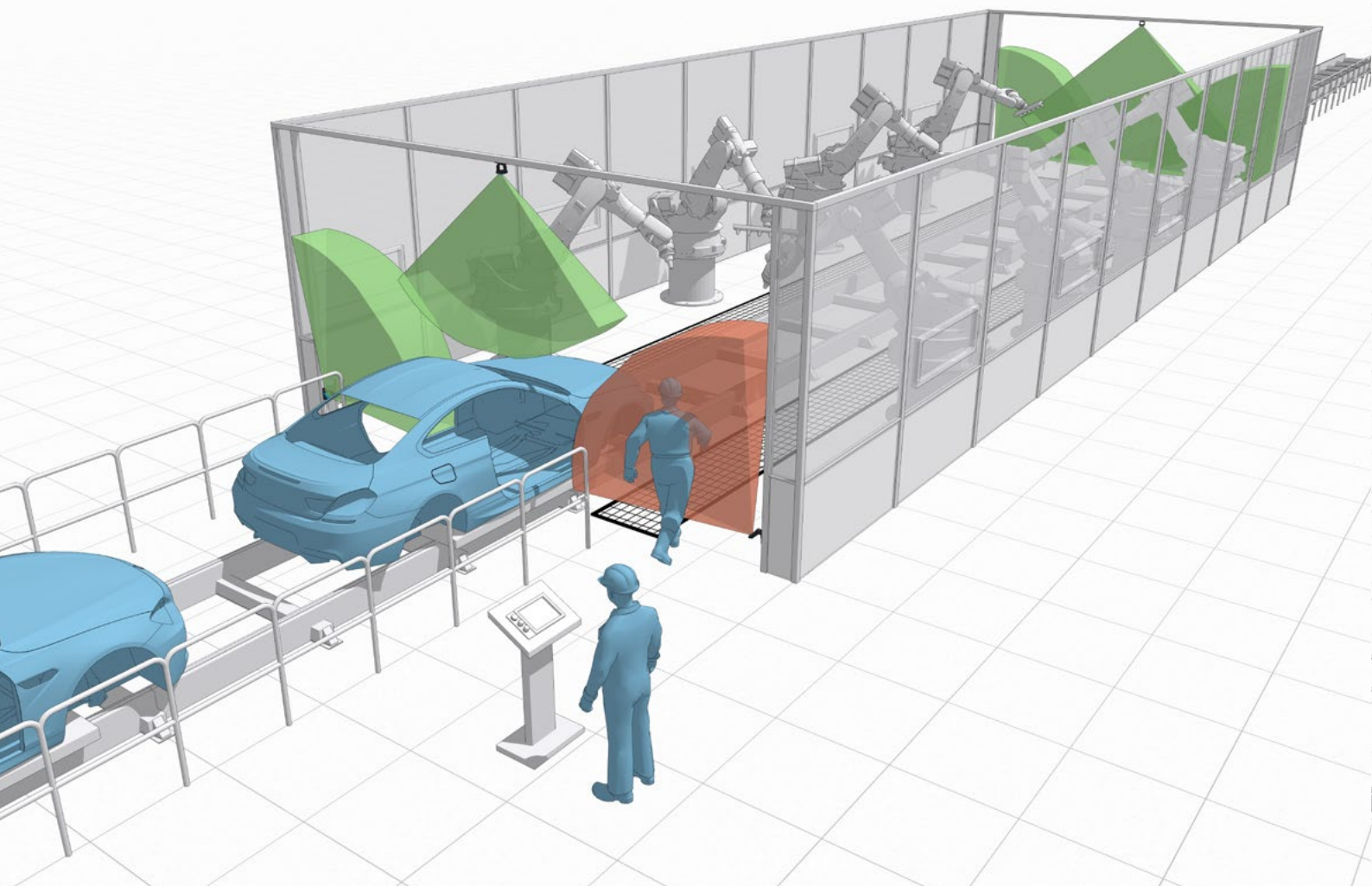

# Restart prevention

## Higher safety in automation robotic cells

Inxpect removes the human error for robotic cells. Inxpect 3D radars thanks to proprietary algorithms prevent unintentional restarts while operator is in the dangerous area and reduce residual risks, increasing efficiency and productivity.

Main features:

- Natively 3D: volumetric coverage
- Adaptive to changing scenarios
- Prevent unintentional restarts
- Improve human/machine interaction
- Remove human error
- Improve productivity

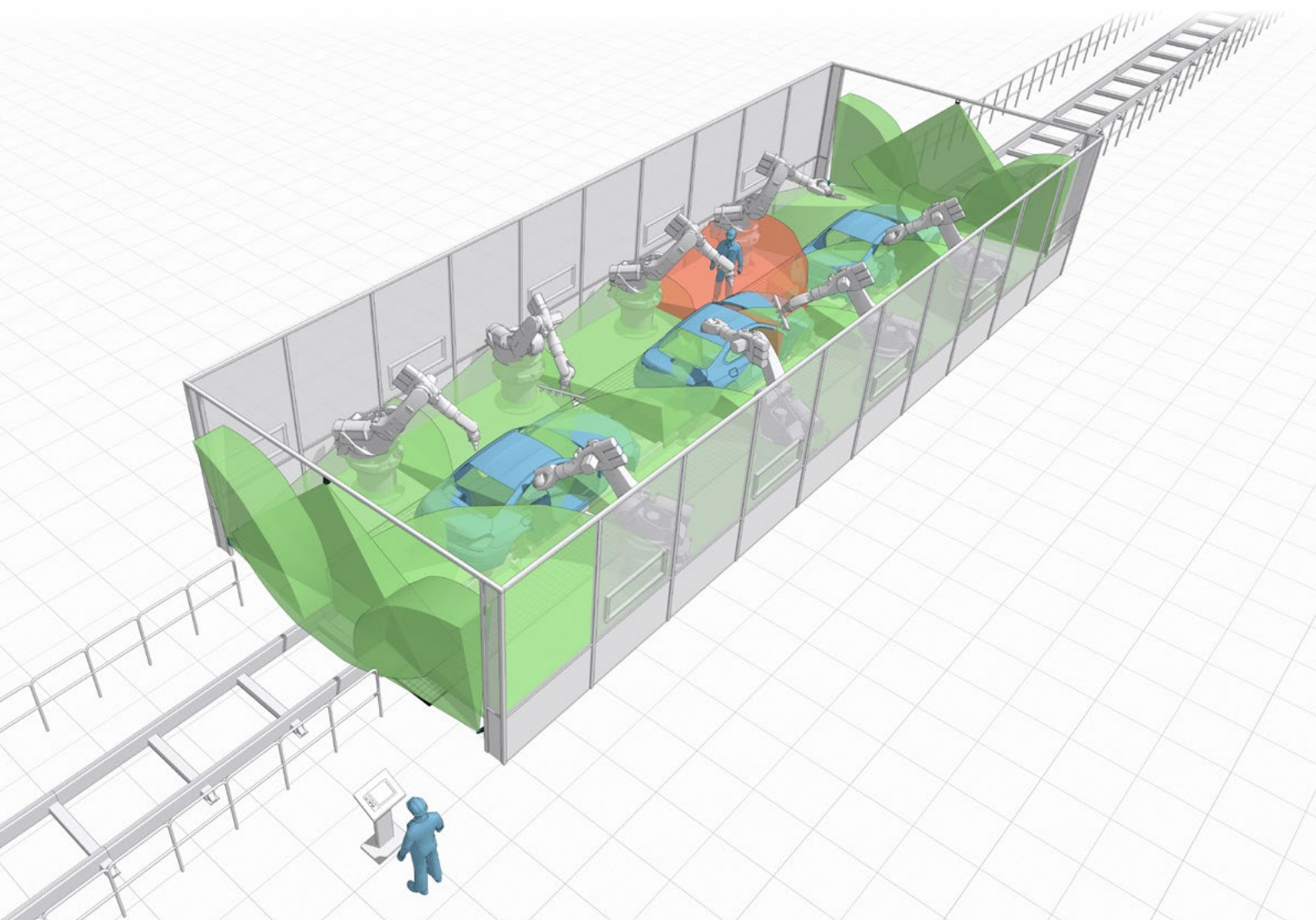

# Restart prevention

## Higher safety in automatic palletizing applications

Inxpect safely monitors access to loading/unloading area. This solution combines optical barriers and radars, redefining the state of the art and reducing residual risk. Inxpect 3D radars ensure the application safety: detecting if there is a operator in the area and stopping the machine until the area is clear.

Main features:

- Natively 3D: volumetric coverage (for both floor and work surface areas)
- Prevent unintentional restarts
- Highly dynamic protection
- Reduce residual risk
- Improve productivity

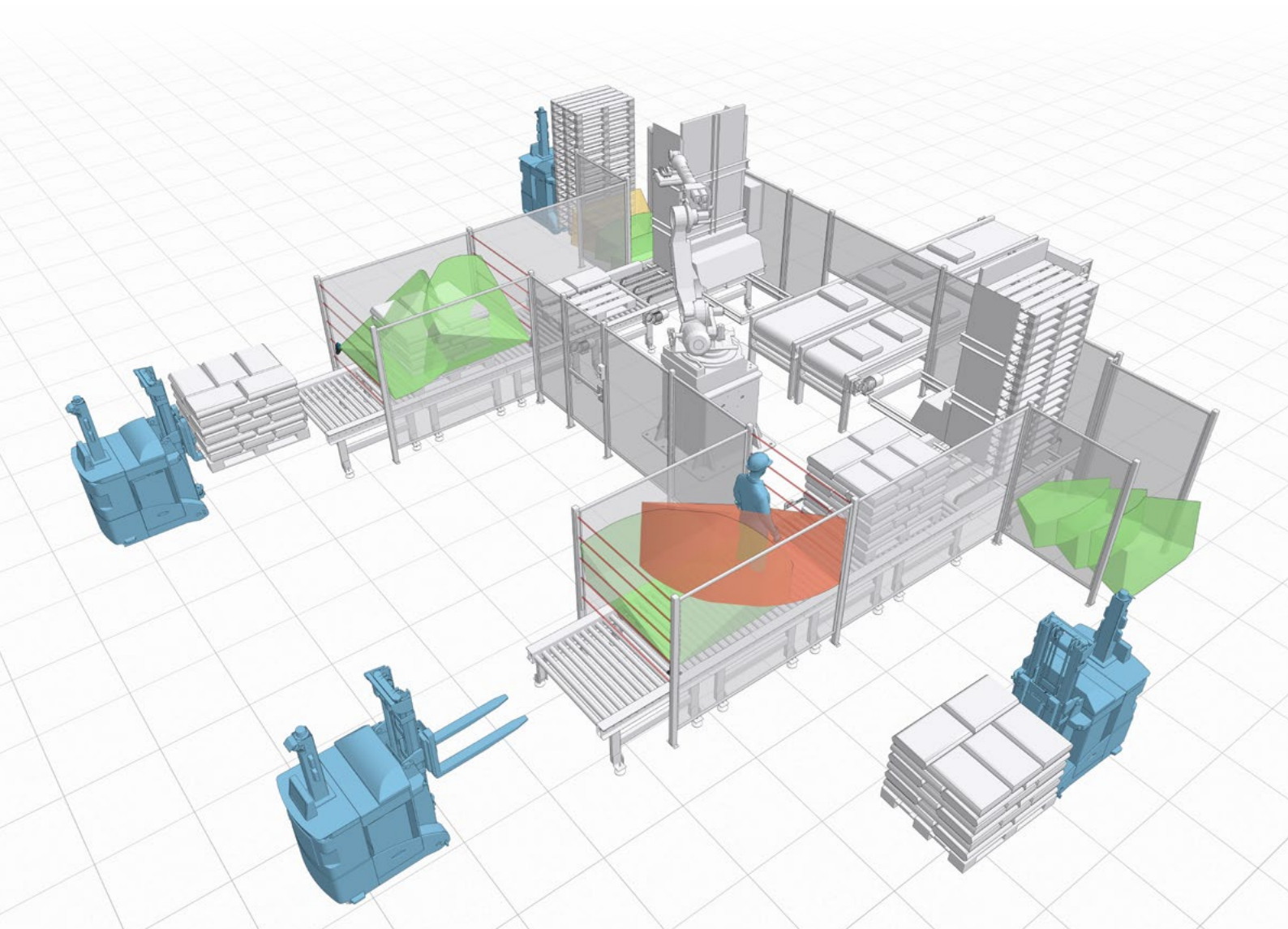



# Restart prevention

## Higher safety in automatic loading/unloading CNC applications

Inxpect redefines the state of the art of automatic loading/unloading CNC applications. Inxpect 3D radars simplify human/machine interaction, prevent unintentional restarts and reduce residual risks, increasing efficiency and productivity.

Main features:

- Natively 3D: volumetric coverage
- Prevent accidental restart
- Simplify access procedures
- Improve human/machine interaction
- Remove human error
- Improve productivity

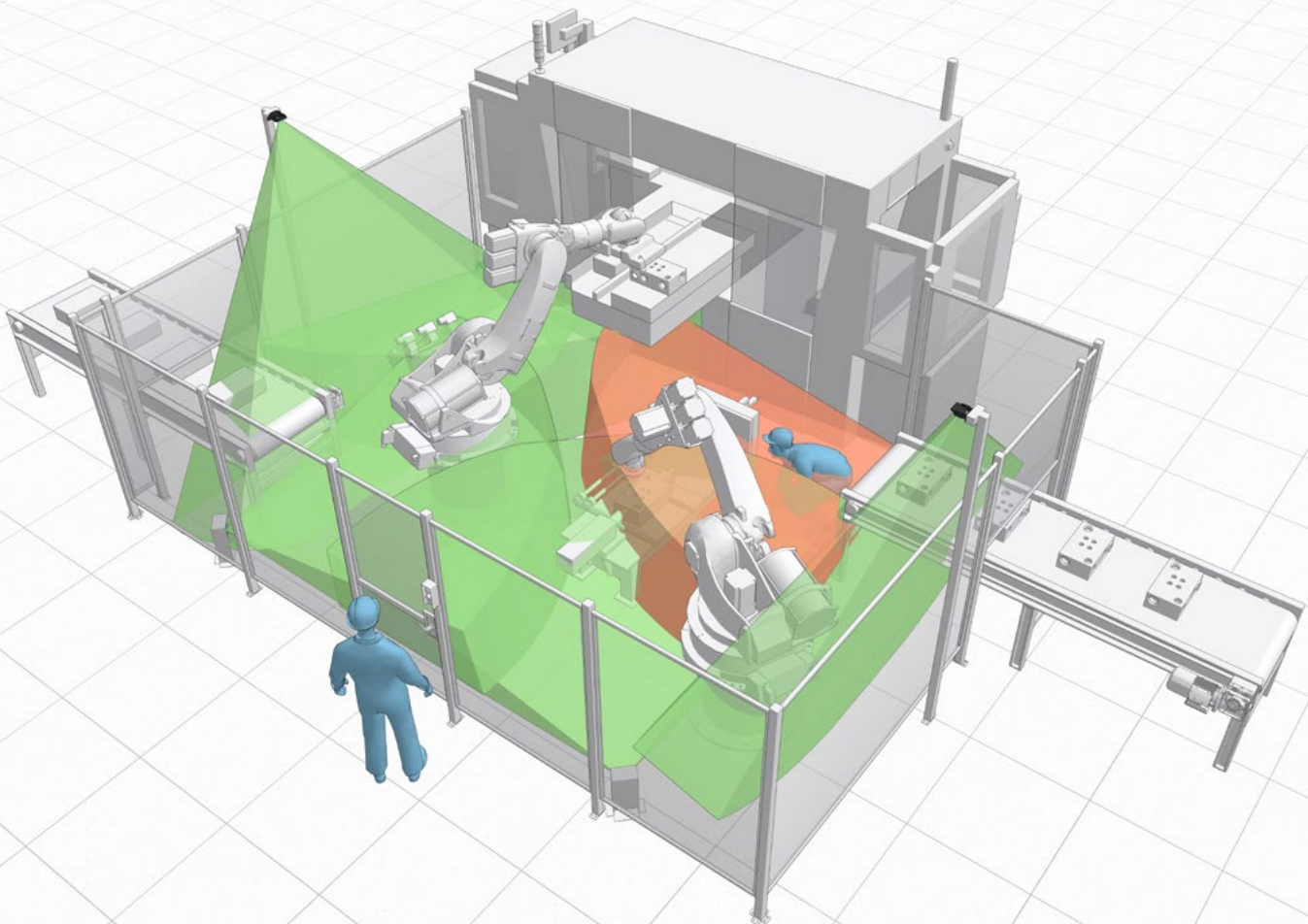







**Inxpect S.p.A.**  
Via Serpente, 91  
25131 Brescia  
T +390305785105  
safety@inxpect.com  
www.inxpect.com



Copyright © 2023 Inxpect S.p.A. - All rights reserved.  
Designed and manufactured in Italy by Inxpect.  
“Inxpect” and its logo are registered trademarks of Inxpect S.p.A.  
Technical specifications subject to change without notice.